



T60

60 Ah | 12.8 V | 768 Wh

Electrical Specifications

Nominal Voltage	12.8 V
Nominal Capacity	60 Ah
Capacity	@ 25 A 144 min
Energy	768 Wh
Resistance	≤ 50 mΩ @ 50% SOC
Self Discharge	< 3% / month
Cell Type	LiFePO ₄

Mechanical Specifications

Measurements (L × W × H)	250 × 160 × 176 mm
Approx. Weight	6.5 kg
Terminal Type	M8
Terminal Torque	9 to 11 N m
Case Material	ABS
Enclosure Protection	IP65

Discharge Specifications

Max. Continuous Discharge Current	60 A
Peak Discharge Current	120 A (≈ 2 s)
BMS Discharge Cut-Off Current	150 A (50 ms)
Recommended Low Voltage Disconnect	11 V
BMS Discharge Cut-Off Voltage	10.4 V
Reconnect Voltage	10.8 V
Short Circuit Protection	200 to 600 μs

Temperature Specifications

Discharge Temperature	-20 to 60 °C
Charge Temperature	0 to 45 °C
Storage Temperature	-5 to 35 °C
BMS High Temperature Cut-Off	65 °C
Reconnect Temperature	48 °C

Charge Specifications

Recommended Charge Current	20 A
Maximum Charge Current	60 A
Recommended Charge Voltage	14.6 V
BMS Charge Cut-Off Voltage	< 15.4 V (0.5 to 1.5 s)
Reconnect Voltage	> 14.6 V
Balancing Voltage	< 14.4 V
Maximum Batteries in Series	4

Compliance

Certifications	CE (Battery) UN38.3 (Battery) RoHS
Shipping Classification	UN 3480, CLASS 9

Measurements

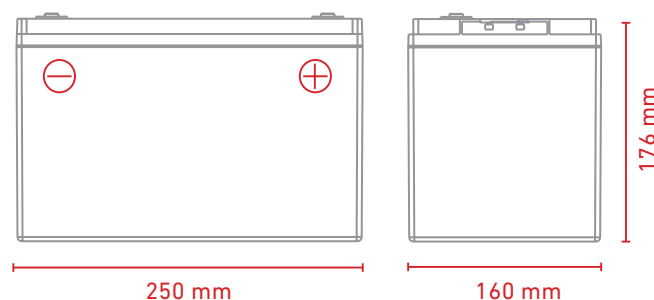

Cycle Life vs. Depth of Discharge (DOD)
Discharge 0.5C / Charge 0.5C (25°C)

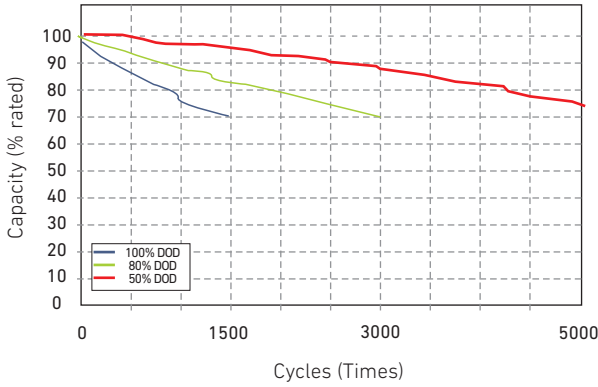

Discharge Voltage Profiles at 0.5C Discharge Rate
(Various Ambient Temperatures)

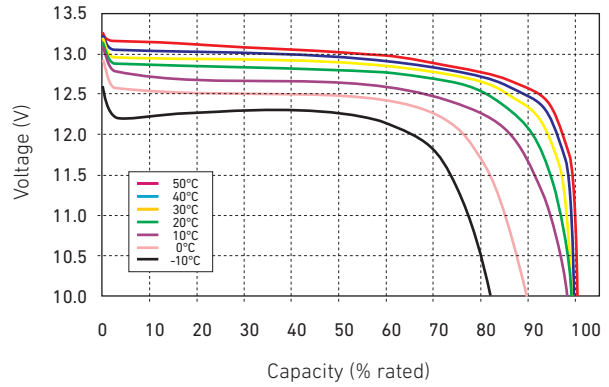

Discharge Voltage Profiles at Various Rates
(25°C Ambient Temperature)

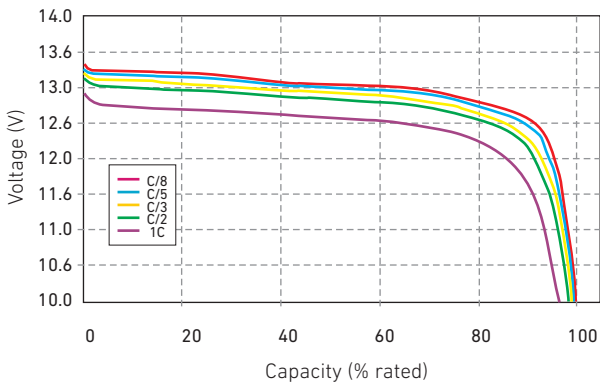

Charging Characteristics (0.5C at 20°C)

